

**How to connect up,
build-in, set up, use and
look after your
B 1442 oven**

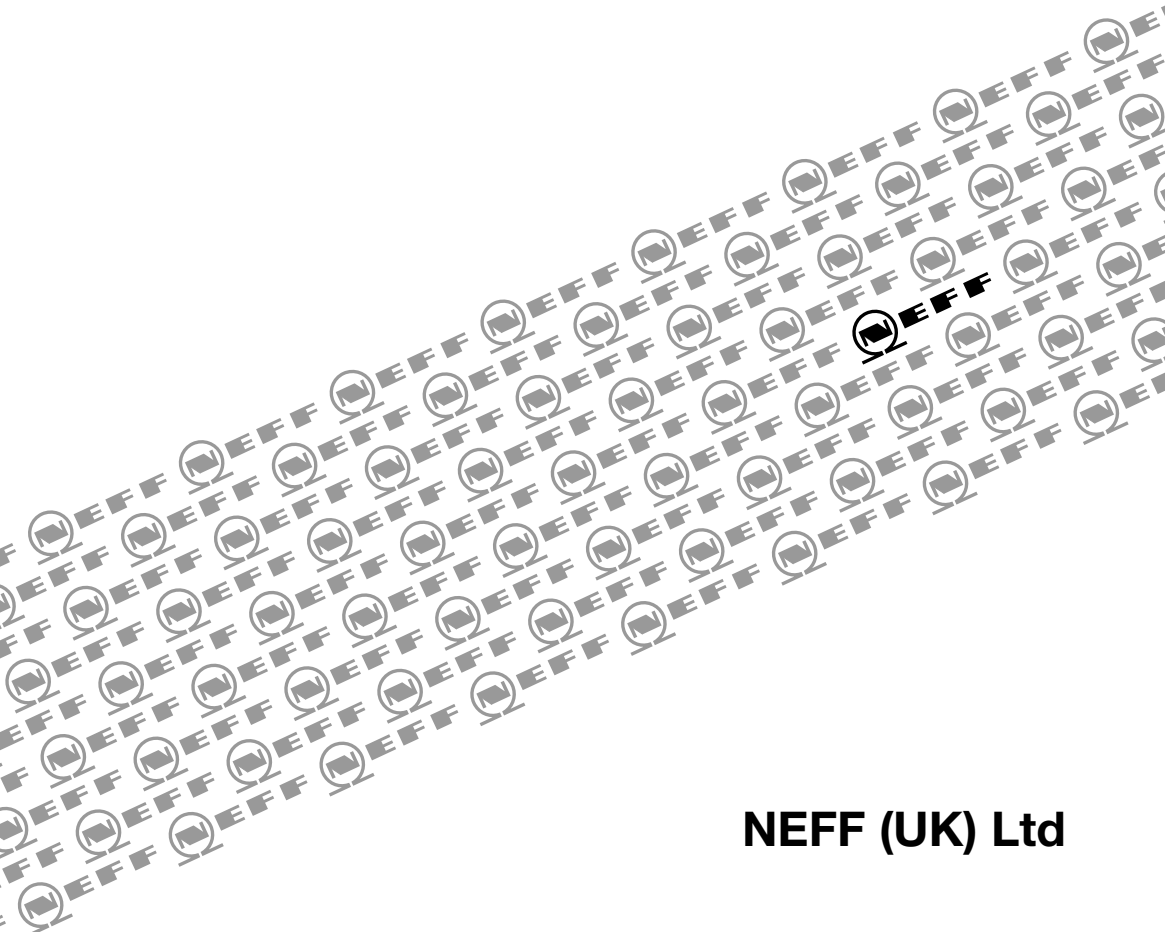

NEFF (UK) Ltd

Table of contents

Important Information	3	Baking	16
Packaging and old appliances	3	Cooking Tips and Helpful Hints	17
Before installation	4	Roasting	18
Safety information	4	Grilling	20
Reasons for damage	5	Circo-roasting	21
Your new cooker	6	Surface grilling	21
The control panel	6	Defrosting and Cooking	22
Function selector	6	Defrosting with circotherm	22
Temperature selector	7	Cleaning and Care	24
Press-down switches	7	Important cleaning basics	24
Shelf positions	7	Catalytic oven surface	26
Accessories	8	Oven Cleaning	27
Before using your Appliance for the first time	9	Removing/installing the oven door	28
Preliminary cleaning	9	Shelf supports	29
Initial burn-in	9	Service and Repair information	30
Subsequent cleaning	9	Trouble-shooting Guide	31
Time of day	9		
Electronic clock	10		
The control panel	10		
Minute timer	10		
Automatic timer	11		
Special functions	12		
Description of Oven Features	13		
Switching the oven ON and OFF	15		

Assembly instructions

For the installer
and kitchen expert

Important installation notes	33
Installation of the built-in oven	34

Important information



Before using your new appliance, please read these Instructions for Use carefully. They contain important information concerning your Personal safety as well as on use and care of the appliance.

The Instructions for Use apply to several versions of this appliance. Accordingly, you may find descriptions of individual features that do not apply to your specific appliance.

Please keep the operating and installation instructions in a safe place; this important documentation may also be of use to a possible subsequent owner.

Packaging and old appliances

Your new appliance was protected by suitable packaging while it was on its way to you. All materials used for this purpose are environmentally friendly and can be recycled. Please make a contribution to protecting the environment by disposing of the packaging appropriately.

Old appliances are not worthless rubbish. Environmentally-conscious recycling can reclaim valuable raw materials.

Before disposing of your old appliance, please make sure that it is unusable, or label it with a sticker stating „Caution, scrap”.



This appliance is labelled in accordance with European Directive 2002/96/EG concerning used electrical and electronic appliances (waste electrical and electronic equipment – WEEE). The guideline determines the framework for the return and recycling of used appliances as applicable throughout the EU.

Up-to-date information on how to dispose of your old appliance and the packaging from the new one can be obtained from your retailer or local authority.

Before installation

Transport damage

Check the appliance after unpacking it. Do not connect the appliance if it has been damaged in transport.

Electrical connection

The cooker may only be connected by an approved specialist. Losses resulting from damage caused by incorrect connection will invalidate warranty claims.

Safety information

Hot oven

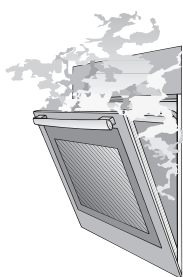

This appliance is intended for domestic use only. Only use the cooker for food preparation.

Open the oven door carefully. Hot steam may escape. Never touch the internal surfaces of the oven or the heating elements. There is a risk of burning. Children must be kept at a safe distance from the appliance.

Never store combustible items in the oven.

Risk of fire. Never place flammable objects onto the hot plates. Fire hazard!

Never place cables of electronic devices onto the hot plates.

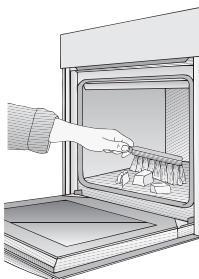

Never clamp leads of electrical appliances in the hot oven door. The insulation on the leads could melt. There is a risk of short-circuiting.

Remove all packaging remnants, e.g. polystyrene parts, from the oven.

Repairs

Incorrectly done repairs are dangerous. There is a risk of electrocution.

Repairs may only be carried out by after-sales service technicians who have been fully trained by BSH.

If there is a fault, switch off the oven fuse at the fuse box.

Call the after-sales service.

Reasons for damage

Baking tray, aluminium foil or dishes on the oven floor

Do not place the baking tray on the oven floor.
Do not cover it with aluminium foil.
Do not place dishes on the oven floor.
This will cause heat accumulation. The baking and roasting times will no longer be correct and the enamel will be damaged.

Slide-in accessories

To avoid damage, insert slide-in accessories carefully.

Baking paper

If using hot air functions , do not place greaseproof paper loosely in the oven (e.g. when heating the oven).
The hot-air fan could draw in the paper which may damage the heater and fan.

Water in the oven

Never pour water directly into a hot oven.
This could damage the enamel.

Fruit juice

When baking very moist fruit cakes, do not put too much on the baking sheet. Fruit juice dripping from the baking sheet leaves stains that cannot be removed.
It is recommended that you use the deeper universal pan.

Cooling with the oven door

Only leave the oven to cool with the door closed. Do not allow anything to become trapped in the oven door. Even if you only leave the oven door open slightly, the fronts of adjacent units may become damaged over time.

Very dirty oven seal

If the oven seal is very dirty, the oven door will no longer close properly when the oven is in use.
The fronts of adjacent units could be damaged.
Keep the oven seal clean.

Using the oven door as a seat

Do not stand or sit on the oven door.

Care and cleaning

Do not use high-pressure cleaners or steam jets.

Your new cooker

Here you will learn more about your new oven. The control panel and its switches and indicators are explained here. The heating modes and the accessories included with your oven will be explained here.

The control panel

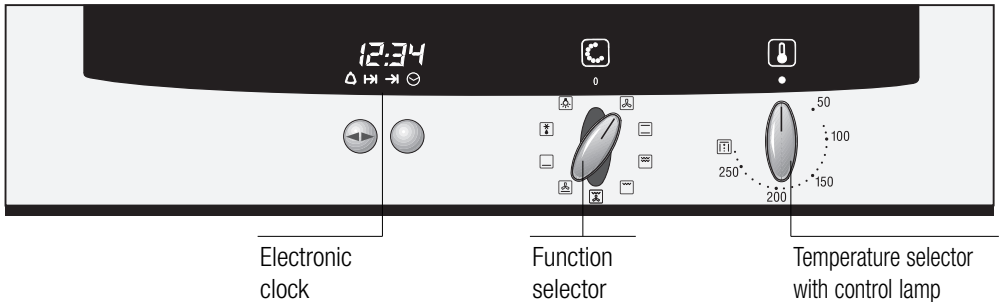

Function selector

Use the function selector to select the type of heating for the oven.

Settings

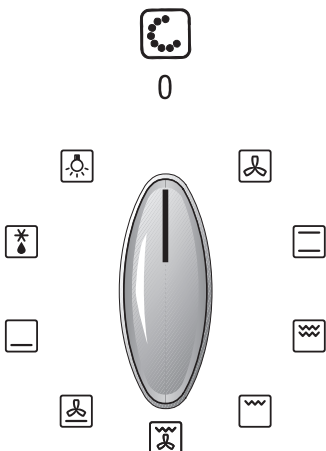

- Circotherm
- Top/bottom heat (conventional heating system)
- Surface grilling, large area grill
- Surface grilling, small area grill (energy-saving grill)
- Circo-roasting
- Circotherm intensive
- Bottom heat
- Defrosting position
- Oven light

Temperature selector

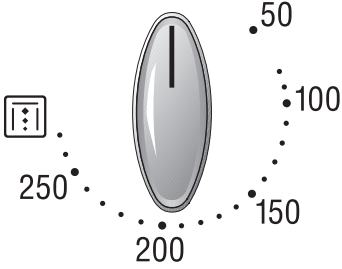

Settings

50–275 Temperature in °C.



Oven Cleaning

Press-down switches

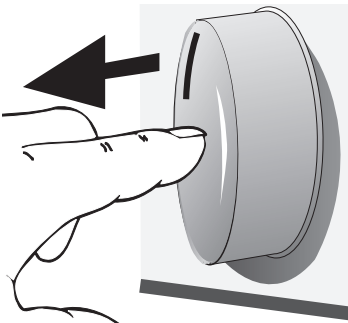

To engage and disengage, depress the switch, making sure that it is in OFF position.

Shelf positions



Your oven features 4 shelf positions. **The shelf positions are counted from bottom to top.**

The numbers are marked in the oven.

When using **hot air function** , **do not use shelf position »2«**, in order not to block air circulation.

Accessories

Your appliance is supplied with:

Universal pan with wire shelf



2 Wire shelves



Additional accessories can be obtained from a specialist dealer. Before ordering, please check the Neff sales literature to confirm which of the following items are available in the UK:

Order no.

Universal pan	Z 1232 X0
Universal pan, non-stick	Z 1233 X0
Glass pan	Z 1262 X0
Soufflé pan	Z 1272 X0
Baking tray, aluminium	Z 1332 X0
Baking tray, enamelled	Z 1342 X0
Baking tray, non-stick	Z 1343 X0
Pizza tray	Z 1352 X0
Wire shelf, high/low	Z 1432 X0
Wire shelf, close mesh	Z 1442 X0
Upgrade set Clou, 3 pieces	Z 1742 X0
Upgrade set Clou, 4 pieces	Z 1752 X0
System steam cooker	N 8642 X0 EU
Pizza stone	Z 1912 X0
Universal oval roaster enamelled	Z 9930 X0

Note:

The baking tray or universal pan may distort while the oven is operating. This is caused by major temperature differences on the utensil. These differences may occur if only one part of the utensil was covered or if deep-frozen food, e.g. pizza, was placed on the utensil.

The distortion will subside again during baking, roasting or grilling.

Before using your appliance for the first time

Preliminary cleaning

Take the accessories out of the oven.

Remove all packaging remnants, e.g. polystyrene parts, from the oven.

1. Clean the appliance exterior with a soft moistened cloth.
2. Remove the shelf supports from the oven.
3. Clean the oven and the accessories with a hot detergent solution.

Please observe the operating instructions furnished with the hob.

Initial burn-in

Before using the appliance for the first time, you must set the time on the electronic clock.

Heat the empty oven for approx. 30 minutes. Select top and bottom heat at a setting of 240° C.

Subsequent cleaning

Clean the oven with a hot detergent solution. Install the shelf supports.

Time of day

Setting the time



After connecting to the mains, or after a power failure, the display **0:00** will blink.

Press the ◀▶ button and set the current time with the rotary knob (e.g. **15:00** hours).

To correct the time, press the ◀▶ button until the symbol flashes.

Then set the time.

Note: The time cannot be corrected if an automatic function has been set (see Electronic clock for cancelling automatic function).

Electronic clock

The electronic clock can be operated with one hand; after pressing the button, set the time with the rotary knob. Settings can be made for as long as the function display flashes (~4 seconds).

The control panel



Minute timer



1. Press the button and set the cooking time (e.g. 5 minutes).
When the timer switches on, the remaining time is displayed.
2. When the time has elapsed, a signal is emitted and the symbol flashes. To stop the signal, press the .

Automatic timer

Automatic switch off



You can switch the oven on and off via the electronic clock.

If you wish to bake or roast food immediately, it is only necessary to set the cooking time.

1. Select the heating system and the oven temperature.
2. Press the ◀▶ button until the ⇨ symbol flashes and set the cooking time with the rotary knob (example: 1 hour and 30 minutes). When the setting has been made, the current time is displayed after approx. 4 seconds. The ⇨ symbol signals automatic mode.
3. When the time has elapsed (example: 1 hour and 30 minutes), a signal is emitted and the ⇨ display flashes. The oven switches off automatically. To stop the signal, press the ◀▶ button.
4. Switch the oven off.
5. To end automatic mode, press the ◀▶ button again.

Automatic switch on and switch off



If the food is to be baked or roasted later on, both the cooking time and OFF time must be set.

1. Select the heating system and the oven temperature.
2. Press the ◀▶ button until the ⇨ symbol flashes and set the cooking time with the rotary knob (example: 1 hour and 30 minutes).
3. Press the ◀▶ button until the → symbol flashes and set the OFF time with the rotary knob (example: 12:30). When the setting has been made, the current time is displayed after approx. 4 seconds. The → symbol signals automatic mode.



Checking, correcting and cancelling settings

Note

4. The oven is automatically switched on and off at the preset times (e.g. 11:00 and 12:30).
5. When the time has elapsed, a signal is emitted and the →| symbol flashes. To stop the signal, press the ◀▶ button.
6. Switch the oven off.
7. To end automatic mode, press the ◀▶ button.

1. To check your settings, press the ◀▶ button until the symbol flashes.
2. If required, correct the settings with the rotary knob.
3. If you want to cancel your settings, turn the set time back to 0:00 and switch the oven off.

The automatic timer is best used with dishes which require little attention.

The minute timer and OFF time can be pre-programmed up to a max. 24 hours.

The settings can be displayed at any time by pressing the ◀▶ button.

Special functions

Masking out the display

1. Press the ◀▶ button for 7 seconds. The display then goes blank and the time continues running in the background.
2. To switch on the display, briefly press the ◀▶ button.

Setting the time

See section "Before using your appliance for the first time".

Dimming the display

Between 22.00 and 6.00 the display is automatically dimmed.

Description of Oven Features

Circotherm



A fan system located in the rear oven wall circulates the circotherm in the oven, achieving an especially effective heat transfer to the food being baked or roasted.

Advantages:

- Simultaneous baking and roasting possible on up to 3 levels
- low soiling of oven interior
- shorter preheating times
- low oven temperatures

Top and bottom heat (Conventional heating system)



The food being baked or roasted is exposed to heat radiation from heating elements located at the top and bottom of the oven cavity.

Baking and roasting is possible on one shelf position only.

Advantages:

- Baking of cake with wet fillings, pizza, quiche, e.g.

Surface grilling

The food being prepared is exposed to heat radiation from the heating element at the top of the oven cavity.

- Particularly effective with flat, small cuts of meat, i.e., steaks, sausages, fish, vegetables and toast.

Advantages:

- the entire grilling surface heats up
- especially useful with large amounts of food

Large area grill



Small area grill



Advantages:

- only the centre area of the grilling surface heats up
- especially useful with small amounts of food
- energy-saving operation

Circo-roasting



With circo-roasting, the air circulating fan and the grilling elements are activated alternately.

The heat generated by the grilling element is evenly distributed in the oven cavity.

Advantage:

- Particularly effective with poultry.

Bottom heat



With this setting, only the heating element at the bottom of the oven cavity is activated.

Advantage:

- Particularly useful with dishes and baked goods that require a distinctive bottom crust or browning.

 Use just before the end of the baking or roasting time.

Circotherm intensive



The circotherm intensive adds the bottom heat to the circotherm.

Advantages:

- Fresh preparation of food with wet fillings or toppings, e.g. pizza and flan.
- Especially suited for frozen products, e.g. pizzas, chips etc.

Defrost



A fan in the rear wall of the oven circulates the air in the oven around the frozen food.

The fan system is running without heating.

Advantages:

- Gentle defrosting.
- Frozen pieces of meat, poultry, bread and cakes defrost evenly.

Oven Cleaning



Oven cleaning  is a regeneration programme.

If the self-cleaning panels in the oven are no longer adequately cleaned during normal day-to-day operation, they will be regenerated with this function. They will then be fully functional again.

Switching the Oven ON and OFF

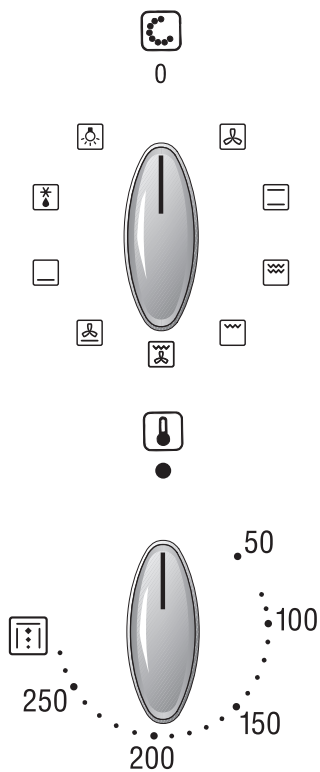

Before switching on your oven, you should decide which heating system you wish to use.

Switching the oven ON:

1. Use the function selector to determine the desired system.
2. Set the temperature control knob to the desired temperature.

The selected temperature will be controlled automatically.

The oven temperature control lamp illuminates when the oven is first switched on, and extinguishes when the required temperature has been reached.

Switching the oven OFF:

To switch the oven OFF, turn both the temperature selector and functions selector to the »0« position.

Notes:

The appliance features a cooling fan which runs until the oven has cooled down.

Baking

Using baking tins

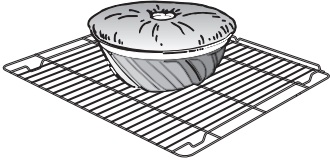

Notes

Always place baking tins in the centre of the baking wire shelf.

We recommend dark metallic baking tins.

Light coloured baking tins made from thin-wall materials lead to longer baking times and uneven browning of the cake.

You can influence the degree of browning by changing the temperature setting.

If a cake collapses after removing it from the oven, consider using a longer baking time, or use a slightly lower temperature setting.

Using tinplate baking tins



Circotherm

Shelf position **1**



Top/bottom heat

Shelf position **1**

If the cake bottom gets too dark:

Check the shelf position. Shorten the baking time, and possibly use a lower baking temperature.

If the cake bottom stays too light:

Check the shelf position. Increase the baking time, select a lower temperature, or use a dark metal baking tin.

Do not place baking forms or high cakes too close to the rear oven wall.

Cooking Tips and Helpful Hints

The bottom of a cake baked on a baking sheet stays too light	Remove from the oven all baking sheets or universal pan currently not in use.
The bottom of a cake baked in a tin stays too light	Use a wire shelf and not a baking sheet to support the cake tin during baking.
The bottom of cake or cookies gets too dark	Set cake or cookies into a higher set of shelf position.
The cake gets too dry	Select a slightly higher oven temperature, and shorter baking time.
The cake is too moist on the inside	Choose a slightly lower baking temperature. Note: Higher temperatures do not shorten baking times (done on the outside, raw on the inside). Choose a slightly longer baking time, allow the dough to rise slightly longer. Add less liquid to the dough.
When baked with circotherm, cake baked in round or square tins gets too dark at the rear	Avoid blocking the air vents at the rear wall of the oven cavity with the cake tins.
Very moist cake dough (e.g. fruit cake) causes a lot of steam to generate in the oven that condenses on the oven door.	You can let the steam escape from the oven and thereby reduce the forming of water droplets by briefly and carefully opening the oven door (once or twice, in case of longer baking times more often).
Very uneven browning when using circotherm	Check the shelf position.
Cake collapses when taken out of the oven	Use less liquid.
To save energy	Preheat only if expressly required by the recipe. Dark baking tins have a higher degree of heat absorption. Residual heat: In the case of longer baking times, you can switch off the oven 5-10 minutes before the full baking time has elapsed.

Roasting

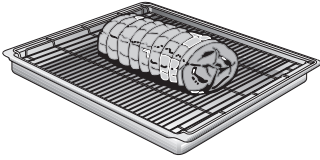

Roasting in an uncovered pot

Place the wire shelf into the universal pan and slide them together into the same shelf position.

Meat can be roasted in the oven in a particularly economical fashion if the weight of the cut exceeds 750 grams.

Rinse the universal pan and/or the roaster with water, and place the meat into it.

With fat meat and poultry, pour 125 to 250 ml of water (to suit the size and kind of roast) into the universal pan. At your discretion, baste lean meat with fat, or cover it with bacon strips.

The roast drippings collecting in the universal pan make a tasty gravy. Dissolve the drippings with hot water, bring to a boil, thicken with corn starch, season to taste and, if required, pass it through a strainer.

No preheating is required. Save energy by putting the roast into the oven while it is still cold.

Roasting in a covered pot

Place the meat into the roasting pot (or Dutch oven), cover it with a matching lid, and place it on the wire shelf in the oven. We recommend that beef roast be prepared in a covered roasting pot.

Tips

Big, high roasts, goose, turkey, duck

= Long roasting times, low temperatures

Medium sized, low roasts

= Medium roasting times, medium temperatures

Small, flat roasts

= Short roasting times, high temperatures

Roasting time per cm of meat height without bones
app. 13-15 minutes

Roasting time per cm of meat height with bones
app. 15-18 minutes

We recommend using the lower of the stated temperatures first.

In general, the lower temperature ensures a more even browning.

For roasting, use only cookware with oven-proof handles.

Prepare large roast directly in the universal pan, without using the wire shelf.

Smaller cuts of meat can be roasted on aluminium foil. To do so, bend the edges of the foil upward, as if to form a dish, and place it on the wire shelf.

After the end of the selected roasting time and with the oven switched OFF, leave the roast in the closed oven for approx. 10 minutes.

The roast is not done on the inside

Use a lower roasting temperature.

Note: Higher temperatures do not shorten roasting times (done on the outside, raw on the inside).

Choose slightly longer roasting times.

Very moist roasts (e.g. roasts prepared with water) cause a lot of steam to generate in the oven that condenses on the oven door.

You can let the steam escape from the oven and thereby reduce the forming of water droplets by briefly and carefully opening the oven door (once or twice, in case of longer roasting times more often).

Grilling

Notes on grilling

 Exercise **CAUTION** when grilling.
Always keep children at a safe distance.

Always close the oven door when grilling.

The grilling temperatures are variable.

Always use the wire shelf and the universal pan.

Always place food to be grilled in the centre of the wire shelf.

If the grill element (heating element) switches OFF automatically, the overheating protection was activated.

The radiator will be reactivated after a short period of time.

Place the wire shelf into the universal pan and slide them together into the same shelf position.

Circo-roasting

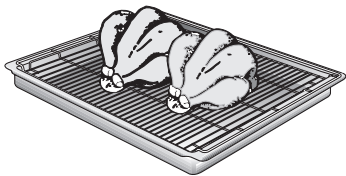

Use this method for particularly crispy poultry or roast (e.g., pork roast with crackling).

Use the wire shelf and universal pan together. Turn large roasts after about half of the total grilling time has elapsed.

To prevent breakage after removing them from the oven, place glass utensils on a dry kitchen towel instead of cold or wet surfaces.

Dependent on the type of food being prepared, combination hot-air and surface grilling can cause an increased degree of oven soiling. Therefore, to prevent burning-in of the soil, thorough cleaning of the oven is recommended after each use.

Whole poultry should be turned after approx. two-thirds of the cooking time has elapsed.

With duck and goose, pierce the skin under the wings to allow excess fat to drain off.

After the end of the selected roasting time and with the oven switched OFF, leave the roast in the closed oven for approx. 10 minutes.

Surface grilling

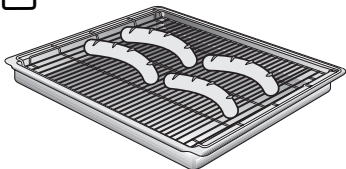
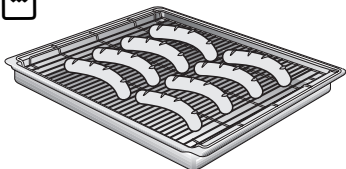

Used for smaller dishes having little height/thickness.

Always use the wire shelf and universal pan together.

Turn the food after approx. two-thirds of the grilling time has elapsed.

At your discretion, lightly baste the wire shelf and the food with oil.

Defrosting and cooking

Defrosting with circotherm

Important heating system
information

For defrosting and cooking of frozen foods,
use circotherm.

**With all frozen foods, follow the food
manufacturers instructions on the package.**

As a rule, **defrosted frozen foods** (especially meats)
require less cooking time than fresh products, since
freezing has a pre-cooking effect.

If **frozen meat** is placed in the oven, the defrosting
time must be added to the required cooking time.

Always defrost **frozen poultry** before cooking
because the giblets must be removed.

For cooking **frozen fish**, use the same temperatures
as for fresh fish.

Frozen ready-to-eat meals in aluminium dishes
may be placed into the oven several at a time.

Frozen vegetables (i.e., when cooking complete
meals) should be cooked in a covered pot together
with the roast. Use only approximately half of the
liquid specified in the recipe. Use fat only for adding
flavour.

Shelf positions

With 1 baking sheet: shelf position **1**

With 2 baking sheets: shelf positions **1 + 3**.

All stated times are approximate guidelines that
vary with the shape and volume of frozen products.

Defrosting and cooking

Raw deep-frozen products or foods from a freezer always defrost at 50° C.

Higher defrosting temperatures may cause the food to dry out.

Defrost **deep-frozen meals packed in aluminium foil or closed aluminium containers** at a setting of 130 – 140° C.

Defrost and warm up **deep-frozen baked goods** at 100 – 140° C. Brush bread, rolls or yeast pastry lightly with water to make the crust more appealing.

Defrost **dry deep-frozen yeast cakes** at 160 – 170° C for 20 – 30 minutes.

Defrost **moist deep-frozen yeast cakes** (with fruit topping) at 160 – 170° C for 30 – 50 minutes after wrapping in aluminium foil to prevent cake from drying out.

Defrost and toast **deep-frozen toast** (with topping) at 160 – 170° C for about 20 minutes.

Frozen pizza:

Please follow the manufacturers' instructions.

Recommended for delicate pastries only (i.e., whipped-cream gateaus).

Turn the function selector switch to the  position. Dependent on size and type of the baked goods, defrost 25 – 45 minutes, take out of the oven and allow to stand 30 – 45 minutes.

With smaller amounts (pastries), the defrosting time is reduced to 15 – 20 minutes and the subsequent standing time to 10 – 15 minutes.

Defrosting position

Cleaning and Care

Important cleaning basics

For cleaning, do not use abrasives, no corrosive cleaners, and no sharp objects.

Do not scratch off burnt-in food residues, but soak them off with a moist cloth and dishwashing detergent.

Cleaning products we particularly recommend can be purchased from our customer service.

Appliance exterior

Stainless steel/ aluminium front

Use commercially available detergents applied to a soft, moistened cloth or a chamois.

Do not use aggressive cleaning agents, abrasive sponges, or coarse cleaning cloths.

On heavy soiling use commercial cleaning agents on matted stainless steel/aluminium surfaces.

Please observe the manufacturer's instructions.

Enamel and glass

Use commercially available detergents applied to a soft, moistened cloth or a chamois.

Oven door pane

The temperature of the pane inside the oven door is reduced by a heat-reflecting coating.

The reduced temperature ensures that visibility through the oven door window is not impaired.

When the oven door is open, this coating may have a bright appearance. This is quite normal and does not indicate a quality defect.

Oven interior

Clean the oven after each use, especially after roasting or grilling.

Food remnants burn in when the oven is reheated. The baked in remnants are very difficult to remove once burnt in.

Note:

To prevent soiling use:

- **CircoTherm hot air.** The CircoTherm hot air mode causes less soiling than the others.
- the universal pan **to bake** very moist cakes.
- suitable utensils (frying pan) **for frying.**

For easier cleaning

you can switch on the oven lamp and take off the oven door.

For cleaning the mating surface of the oven door at the front of the oven, the door should be removed.

Use hot soapy water or a vinegar solution.

It is best to use oven cleaner if the oven is very dirty. Only use oven cleaner in a cold oven.

We recommend cleaning gels because these can be applied with greater precision.

 Do not clean the warm oven with any of the cleaning products specifically designed for this purpose.

Leave the oven open so that it can dry after cleaning.

Note:

Enamel is baked on at very high temperatures.

This can cause some slight colour variation. This is normal and does not affect the function. Do not use coarse scouring pads or strong cleaning agents to remove such discolorations.

The edges of thin trays cannot be completely enamelled. As a result, these edges can be rough. Anti-corrosion protection is guaranteed.

Enamel areas in the oven

Catalytic oven surfaces

Cleaning the catalytic surfaces of the oven

The rear wall, the oven ceiling and the side walls of the oven are coated with self-cleaning enamel. The surface cleans itself while the oven is in operation. Large splashes sometimes only disappear after the oven has been used several times.

Never use oven cleaner on catalytic surfaces of the oven.

Should the enamel become slightly stained, this will not affect its self-cleaning properties.

Oven Cleaning

Automatic oven cleaning

Oven cleaning  is a regeneration programme. If the self-cleaning panels in the oven are no longer adequately cleaned during normal day-to-day operation, they will be regenerated with this function. They will then be fully functional again.



Take the accessories and utensils out of the oven.

Before switching on automatic oven cleaning, thoroughly clean the areas of the oven that do not have self-cleaning panels, e.g. enamelled areas such as the oven floor, inner door. This will prevent residue from burning in.

You can select the duration of automatic oven cleaning via the electronic clock.

 The oven becomes very hot during automatic oven cleaning – always keep children away.

Setting procedure

1. Rotate the function selector to Circotherm  and the temperature selector to Oven Cleaning  (**270° C**).
Heat up the oven for 1 hour.

Switching off oven cleaning

2. Rotate the temperature selector and the function selector to 0.
The oven is cooled by the fan which continues running.

When the oven has cooled down

Remove the grease film from the parts which are not self-cleaning with a damp cloth.

Wipe the salt residue off the self-cleaning parts with a damp cloth.

Replacement side, roof and rear panels are available from customer service.

Note: exchange of roof and rear panels should only be carried out by an approved service engineer.

Removing/installing the oven door

Oven door

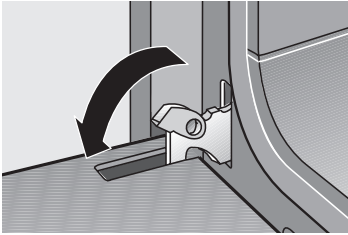

Note: To make the manual cleaning steps following the automatic oven cleaning function more convenient, the appliance features the following options.

Removing the oven door

1. Fully open the oven door.
2. Move the catch levers on the right and left-hand sides to the fully open position.

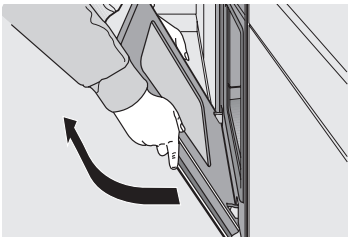

3. Placing the door at an upward angle toward you, grasp the door with both hands and lift it out of the hinges toward you.

When pulling the door out, make sure that you do not reach into the hinge. There is a risk of injury.

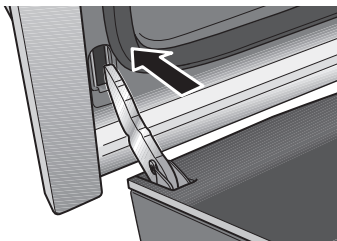

Hanging the oven door

1. Set both hinges into their respective receptacles on the left and right, and swing the oven door downward.
2. Close the catch levers on the left and right.
3. Close the oven door.

Shelf supports

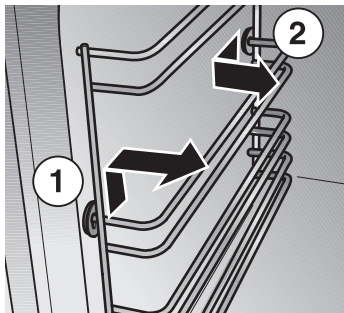

Removing

You can remove the shelf supports for cleaning.

1. **At the front**, press the shelf supports up and take it off.
2. **At the back**, pull the shelf supports forward and take it off.

Clean the shelf supports using washing-up liquid and pan scrapers or brushes.

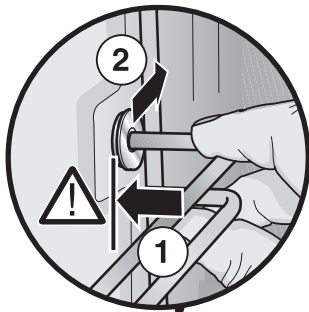

Replacing

The shelf supports fit on the left and right side.

The indentation (a) must always be at the bottom.

1. **At the back**, put the shelf support in as far as it goes.
2. Push the shelf support back.

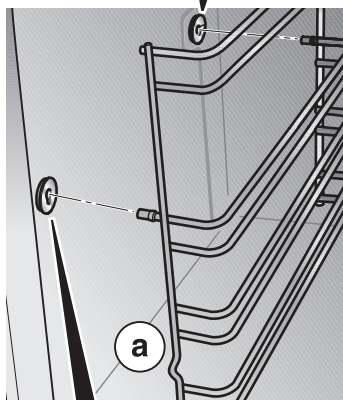

3. Insert the front of the shelf support as far as it will go.
4. Push the shelf support down.

Service and Repair Information

In the event of problems or repairs that you cannot solve or perform yourself, our customer service will be happy to help. Check the customer service directory for a customer service facility in your area.

Caution: Calling the customer service because of an operator error can be very costly!

E No and FD No

You can find this information on the appliance's nameplate. The nameplate is located on the appliance, behind the oven door, on the left bottom edge of the oven.

In the event of a customer service request, please have the following information handy:

E-Number	FD
----------	----

Replacing the oven light

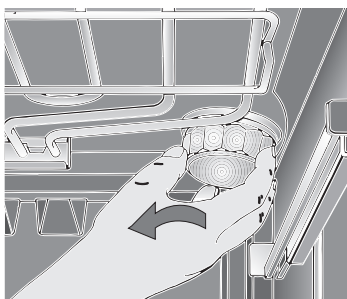

Caution: Unplug the appliance or remove the fuse! By actuating the miniature circuit-breaker or by unscrewing the fuses in the fuse box in your house.

1. To prevent damage, place a towel into the cold oven.
2. Unscrew the lamp cover by turning it counter-clockwise.
3. Replace the lamp.
 - Type: Incandescent bulb E 14, 220 – 240 V, 40 W, heat-resistant to 300° C
 - You may obtain this bulb from your customer service or from your appliance dealer.

Replacing the oven door seat

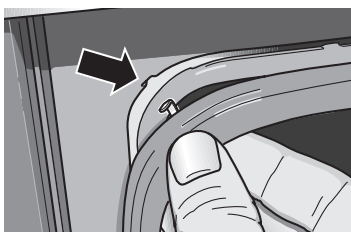

Remove the defective oven door seal by simply unhooking it.

You may obtain the new oven door seal from your customer service.

Trouble-shooting Guide

Calling the customer service is not always really necessary. In some cases, you can remedy the situation yourself. The following table may contain some helpful tips.

Important general safety guidelines:

Service or repair work on the electronic components may only be performed by a qualified expert. Without exception, prior to starting such repairs, the appliance must be disconnected from the mains. This may be accomplished by tripping the automatic fuse or by removing the fuse from the fuse box that controls your flat or apartment.

Problem	Possible cause	Remedy
. . . if there is a general failure of all electrical functions, i.e., the control lamps have suddenly ceased to function.	Defective fuse	Check the fuse in the fuse box, and replace if required.
. . . if liquids or thin viscous dough are distributed at a visibly uneven thickness?	The appliance has not been placed or installed plumb-and-level.	Level the appliance using the leveling feet, or check the installation.
. . . if the oven suddenly stop functioning?	The electronic clock is set to an automatic timing cycle.	Set electronic clock to operation without automatic timer: 1. Press the ◀▶ button. 2. Reset ON time ↪ to 0:00.
. . . if the oven suddenly stop functioning and the electronic clock flashes 0:00?	The power supply was briefly interrupted.	Reset the time of day.
. . . if electronically control functions fail?	Energy pulses (e.g. lightning flash).	Reset the relevant functions.

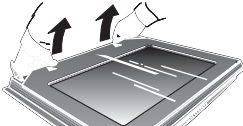
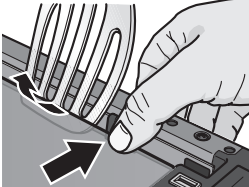
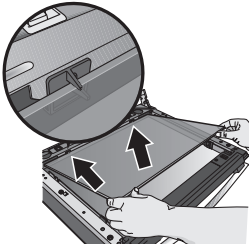
Problem	Possible cause	Remedy
. . . if smoke is generated during roasting or grilling?	Roasting temperature to high. Wire shelf or universal pan slid in incorrectly.	Place wire shelf into universal pan and insert together in shelf position.
. . . if enamelled slide-in parts show mat bright stains?	Normal occurrence due to dripping meat juices.	Not available.
. . . if the glass pane or window of the oven door become clouded?	Normal occurrence, due to existing temperature difference.	Switch on the oven for app. 5 minutes at 100° C.
. . . if the oven shows increasing condensation water?	Normal occurrence, e.g. in the case of cakes with very moist topping (fruit) or roasts.	Briefly open the oven door occasionally during baking or roasting, wipe up the condensation water after operation.
. . . if the panes of the oven door are dirty on the inside after some time of use?	Normal soiling. 	Remove the oven door and place it facing down on a clean and soft surface. Grip the door glass next to the hinges, pull the upward and remove it.
		Press in the retaining clip with your thumb on one side and disengage the inner door glass e.g. with the spatula, then repeat on the other side.
		Installation after cleaning: Insert inner door glass into the holder. First engage the right side and then the other side.
		Hang door glass and press down next to the hinges until it clicks into place.

Assembly Instructions

For the installer
and kitchen expert!

Important installation notes

Properly dispose of **packaging materials**.

Do not use **oven door handle** for transporting or handling the unit during installation.

WARNING: Connection and first start of the appliance may only be performed by an authorised specialist.

Connection have to be made using a mains connection cable not lighter than H05RR-F 300 V / 500 V Rubber Flexible Cable or H05VV-F 300V / 500V PVC Flexible Cable.

Rated consumption, rated voltage and type no. of the appliance:

See appliance nameplate behind the oven door to the left beneath the side edge of the oven.

The unit's nameplate is located at on the sidewall of the unit.

Electrical safety of the appliance can be ensured only if the equipment earth in the building installation has been installed according to regulations.

A separator must be installed in the household circuit. A suitable separator is a switch that has a contact gap of more than 3 mm and interrupts all poles. Other examples are LS switches, fuses and contactors.

The connection diagramm is located on the rear panel of the appliance.



In the case of repairs interrupt all power connections to the unit.

The properly installed appliance must be covered on all sides in such a fashion that not even components with rough insulation are exposed to the touch.

The cover must be removable with tools only.

Installation of the built-in oven

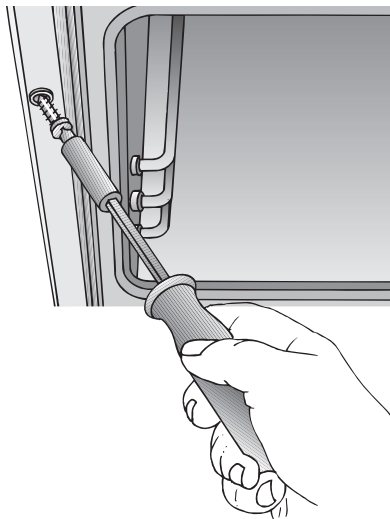

Push the oven into the cabinet aperture and align the unit until it is in a **level position**.

Open the oven door and, using one screw on each side, fasten the built-in oven to the side strips of the conversion cabinet.

When screwing in the two screws (enclosed in a bag with the built-in oven), ensure that they are pointing outwards at a slight angle. Please use these screws only.

Verify that the built-in oven is positioned securely and in a **level position**, and that the required installation dimensions have been maintained.

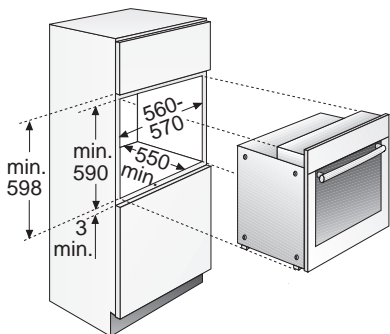

Furniture requirements

Oven housings from virtually all lines of kitchen furniture are suitable for installing the built-in oven. However, the veneers or plastic laminates on the conversion cabinets must be applied with heat-resistant adhesive (90 C).

If plastic laminates or cement are not sufficiently heat-resistant, warping, bubbling or detachment of the finish may result.

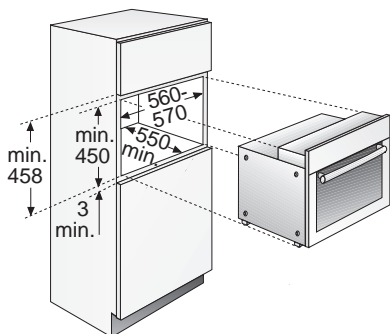

NEFF (UK) Ltd.
Grand Union House,
Old Wolverton Road,
Old Wolverton
Milton Keynes, MK12 5PT
Tel: 01908 328300
Fax: 01908 328399

9000 039 323
Printed in Germany 0806 Es.